

JUNG PUMPEN COMPLI 1000 SEWAGE LIFTING STATIONS

APPLICATION

With their performance graduations, the compli 1000 disposal units have been designed for use in detached houses, in several residential units or in commercial buildings. During the design work, special attention was given to easy handling, space-saving erection and uncomplicated installation.

The submersible unit is permitted for general use in areas subject to flooding. The control unit has to be fitted in a well ventilated flood-proof room.

The PE tank has freely accessible drains, a cleaning opening at the top and a clamp-type inlet flange for an installation. The inlet height can be variegated according to the feeding pipe:

- DN 100: 180-205 mm (left), 250-300 mm (center) and 290-340 mm (right), each continuously adjustable
- DN 150/DN 50: 180 mm (left), 275 mm (center) and 315 mm (right)

For the connection of a DN 100 feeding pipe a reducer DN 150/100 is enclosed. The tank has vertical inlet in DN 150 or DN 100. If not in use, the rear inlet must be closed with the plug set DN 150 (accessory).

The vortex impeller of the pump offers the safety you can rely on. Duplex systems have two pump units on one tank which are switched alternately or, if and when required, they are operated both in order to cope with peak load or reserve operation.

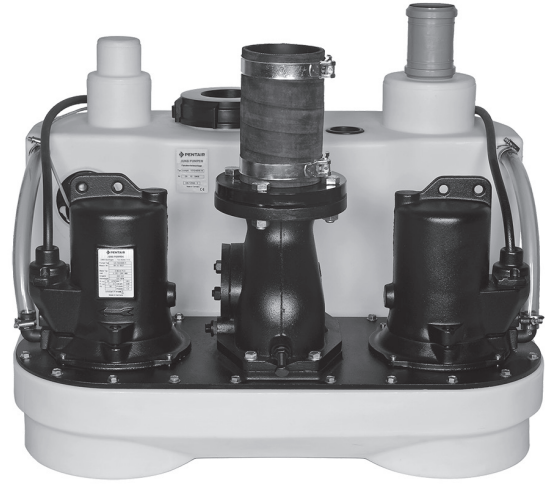

compli 1000

- Ready to plug in
- Submersible
- Clamp-type inlet flange
- Versatile connection facilities
- PE tank
- Vortex impeller

PERFORMANCE

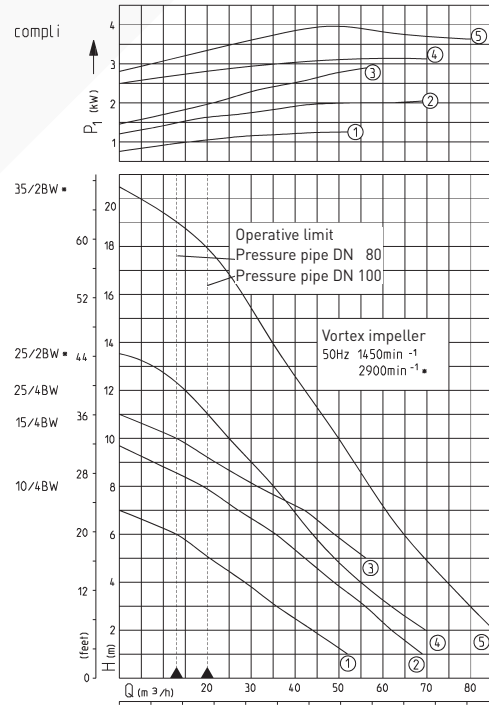

42884-02

We reserve the right to change specifications without notice

Pump performance is subject to ISO 9906 tolerances

The minimum flow velocity in the pressure piping must be 0.7 m/s according to EN 12056.
This data is represented in the performance curve as a limit of application.

JUNG PUMPEN COMPLI 1000

SEWAGE LIFTING STATIONS

SEWAGE LIFTING STATIONS

Type	Tank capacity l	Inlet height mm	Free passage mm	Clamp-type inlet flange	Connect-ing flange PN 10	For connect-ing pipe	Ventila-tion	Weight approx.	Code No.
compl 1010/4 BW E	115		70	DN 150	DN 80	DN 100	DN 70	115 kg	JP09273
compl 1010/4 BW	115		70	DN 150	DN 80	DN 100	DN 70	115 kg	JP09829
compl 1015/4 BW	115	Variable 250 up to 300 mm	70	DN 150	DN 80	DN 100	DN 70	115 kg	JP09830
compl 1025/4 BW	115		70	DN 150	DN 80	DN 100	DN 70	115 kg	JP09831
compl 1025/2 BW	115		70	DN 150	DN 80	DN 100	DN 70	125 kg	JP09461
compl 1035/2 BW	115		70	DN 150	DN 80	DN 100	DN 70	132 kg	JP09462

PERFORMANCE

Type	Delivery head H [m]	1	2	3	4	5	6	7	8	9	10	11	13	15	17
compl 1010/4 BW und BW E	Delivery rate Q [m ³ /h]	52	44	37	29	22	13								
compl 1015/4 BW		69	62	56	49	42	36	27	19						
compl 1025/4 BW						56	49	42	32	22	13				
compl 1025/2 BW		69	64	58	52	47	42	37	33	28	23	20	8		
compl 1035/2 BW		85	80	75	71	66	62	57	54	50	47	44	36	30	21

ELECTRICAL DATA

Type	Type of current	Voltage Volt	Motor rating kW P ₁	P ₂	Current Ampere	Cable (4 m) Tank control	Cable (1.5 m) Control plug	Plug
compl 1010/4 BW E	1-phase	1/N/PE~230	1.55	1.10	7.1	H07RN-F-4 G 1.5	H05VV-F-3 G 1.5	Safety-
compl 1010/4 BW	3-phase	3/N/PE~400	1.3	1.0	2.8	H07RN-F-6 G 1.5	H05VV-F-5 G 1.5	CEE-
compl 1015/4 BW	3-phase	3/N/PE~400	2.2	1.7	3.9	H07RN-F-6 G 1.5	H05VV-F-5 G 1.5	CEE-
compl 1025/4 BW	3-phase	3/N/PE~400	3.0	2.2	5.1	H07RN-F-6 G 1.5	H05VV-F-5 G 1.5	CEE-
compl 1025/2 BW	3-phase	3/N/PE~400	3.3	2.6	5.4	H07RN-F-6 G 1.5	H05VV-F-5 G 1.5	CEE-
compl 1035/2 BW	3-phase	3/N/PE~400	4.8	4.0	8.2	H07RN-F-6 G 1.5	H05VV-F-5 G 1.5	CEE-

Mounting arrangement

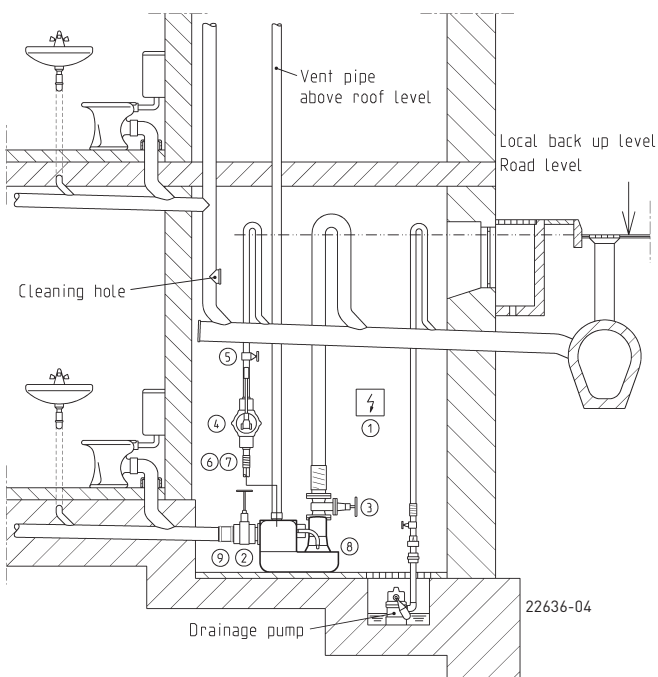

All types have DN 80 / PN 10 connecting flange, however with pipe socket DN 100. For this reason, non-return valves and shut-off valves for the pressure pipe need to be chosen for DN 80 only in case of direct erection. The downstream pressure pipe is connected to DN 100 by an elastic connection.





In keeping with the construction and testing principles of German / European standard DIN EN 12050, sewage lifting stations are to be used for the transport of faecal matter and domestic waste-water in building drainage systems as described in German standard DIN 1986 T3. In keeping with the stipulations of German / European standard DIN EN 12056-4 they have to be mounted with collecting tanks inside building permitting a free space of 60 cm for operation and repair. The pressure pipe has to be passed above the locally defined backpressure level and a non-return valve tested in keeping with German / European standard 12050-4 has to be mounted. In keeping with German / European standard 12056 the ventilation pipe has to be passed up to the roof.

DIN EN 12056 paragraph 5.1 In applications where the waste-water inlet must not be interrupted a double system has to be installed.

JUNG PUMPEN COMPLI 1000

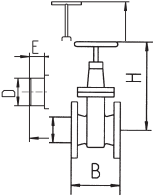
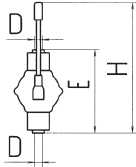
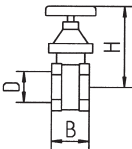
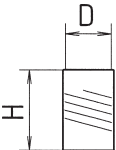
SEWAGE LIFTING STATIONS

ACCESSORIES

		Art.-Nr.															
	1 Rechargeable battery for control for mains-independent alarm	JP44850															
	2 PVC sluice valve (with two pipe sockets) for 4" inlet (DN 100) PN 1	<table border="1"> <thead> <tr> <th>H</th> <th>B</th> <th>E</th> <th>F</th> <th>D</th> </tr> </thead> <tbody> <tr> <td>360</td> <td>295</td> <td>60</td> <td>81</td> <td>110</td> </tr> <tr> <td>660</td> <td>450</td> <td>110</td> <td>105</td> <td>160</td> </tr> </tbody> </table>	H	B	E	F	D	360	295	60	81	110	660	450	110	105	160
	H	B	E	F	D												
360	295	60	81	110													
660	450	110	105	160													
	3 Sluice valve* for 3" pressure side (DN 80), PN 10, DIN EN 1171	<table border="1"> <thead> <tr> <th>H</th> <th>B</th> <th>D</th> </tr> </thead> <tbody> <tr> <td>315</td> <td>180</td> <td>DN 80</td> </tr> </tbody> </table>	H	B	D	315	180	DN 80									
H	B	D															
315	180	DN 80															
	4 Hand diaphragm pump for emergency purposes (up to H_{geod} 15 m)	<table border="1"> <thead> <tr> <th>H</th> <th>E</th> <th>D</th> </tr> </thead> <tbody> <tr> <td>ca. 640</td> <td>430</td> <td>1 1/2"</td> </tr> </tbody> </table>	H	E	D	ca. 640	430	1 1/2"									
H	E	D															
ca. 640	430	1 1/2"															
	5 Stop valve, 1 1/2" (DN 40), PN 16	<table border="1"> <thead> <tr> <th>H</th> <th>B</th> <th>D</th> </tr> </thead> <tbody> <tr> <td>125</td> <td>max. 60</td> <td>1 1/2"</td> </tr> </tbody> </table>	H	B	D	125	max. 60	1 1/2"									
H	B	D															
125	max. 60	1 1/2"															
	6 Elastic connection 1 1/2" (DN 40), PN 4	<table border="1"> <thead> <tr> <th>H</th> <th>D</th> </tr> </thead> <tbody> <tr> <td>120</td> <td>50</td> </tr> </tbody> </table>	H	D	120	50											
H	D																
120	50																
	7 Clamp 1 1/2"	JP44763															
	8 Seal leak detector DKG (for 25/2 BW and 35/2 BW), per pump	JP44900															
	9 Opening set DN 150 (required for lateral connection)	JP43156															

* with screws and seal

JUNG PUMPEN COMPLI 1000

SEWAGE LIFTING STATIONS

TECHNICAL DATA

Pump

Vertical, single-stage, submersible, vortex impeller, volute casing with DN 80 /DN 100 vertical outlet suitable for DN 100 pipework, flanged to PE tank with cleaning opening and pre-mounted duplex swing-type check valve.

Bearing

Common shaft for pump and motor, grease-packed ball bearing.

Motor

Submersible, IP 68 type of protection, insulation class F, winding thermostats for the protection of the drives against overheating, automatic start-up by three-contact circuit and control. Connection to mains by 16 A CEE plug or plug with earthing contact, S 3 type of operation in keeping with German standard VDE.

Seal

Double 10/4-25/4 BW radial shaft sealing ring, 25/2 BW and 35/2 BW silicon carbide mechanical seal independent of rotation and safe to run dry. Oil chamber with double radial shaft sealing ring towards the motor compartment. Connection possibility for seal leak detector on 25/2 BW and 35/2 BW.

Materials

Tank made of corrosion resistant and non-polluting polyethylene; pump and motor housing, single-vane impeller and non-return valve made of wear-resistant grey cast iron; shaft made of stainless steel (versions 10/4-25/4 BW) or completely covered towards the media (version 25/2 and 35/2 BW); rubber inlet hose.

Scope of supply

Ready for plug in sewage lifting unit according to DIN EN 12050-1 with clamp flange DN 150, reducer DN 150/100, two built-on subm. sewage pumps and connection flange DN 80 with pipe socket \varnothing 110 mm, elastic connection c/w hose clamps, PVC collar DN 70 for ventilation connection, pre-mounted duplex swing-type check valve and autom. level controller, control unit (IP 44) c/w motor protection, motor contactor, transformer, mains-dependent alarm unit and potential-free contact for collective failure messages, with optical display of sense of rotation (only in case of three-phase current), alarm and operation, and 2 x manual-0-automatic switch. To be fitted with a micro-processor control as well upon request.

Cable between tank and control 4 m, cable between control and plug 1.5 m. Accessories to be ordered according to the mounting drawing.

Standard DIN EN 12056-4, paragraphs 5.1 and 5.2

- Working area of 60 cm above and around all parts of disposal unit that have to be operated.
- Pump sump for the drainage of the operation room
- Swing-type check valve on the pressure side
- Stop valve on the pressure side
- Stop valve on the inlet side
- Disposal units have to be mounted buoyancy-proof



Dimensions compli 1000 (mm)

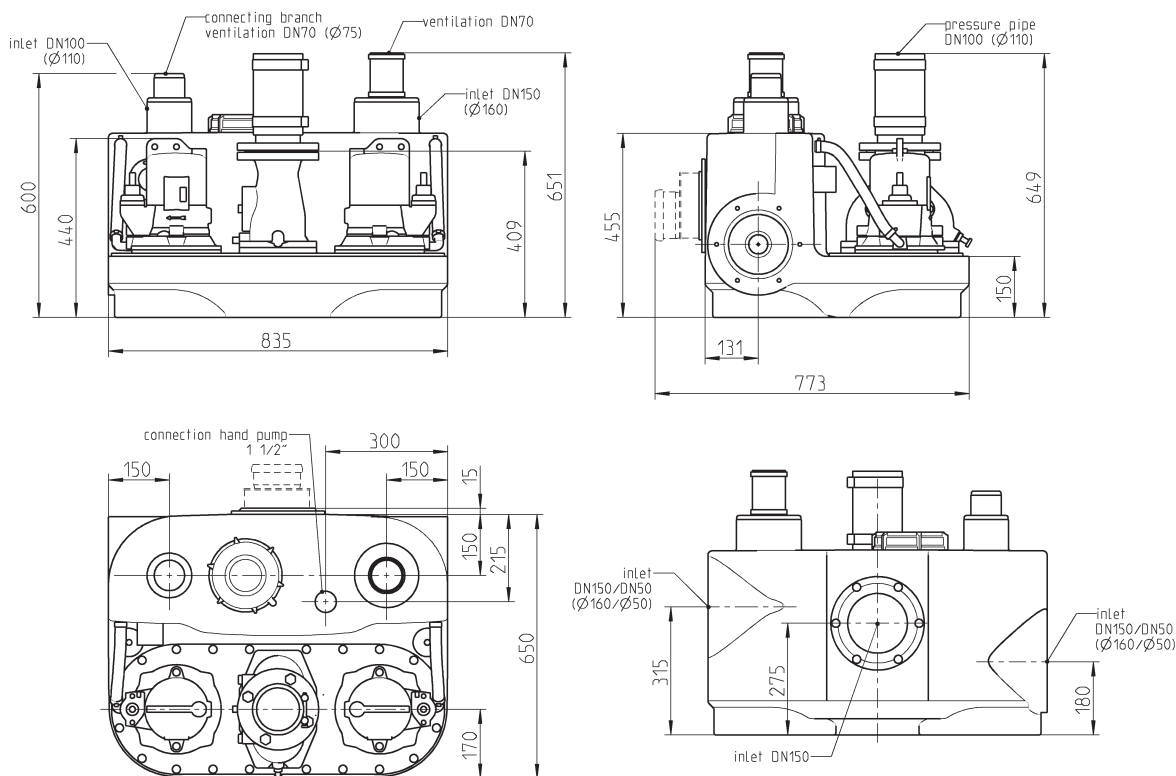

Additional inlets could be made by sawing the pre-formed tank socket or sleeve.

42938-00